

INSTRUCTIONS FOR USE

ENTYVIO® (en ti' vee oh) **PEN** (vedolizumab)
injection, for subcutaneous use

Single-dose prefilled pen

This Instructions for Use contains information
on how to inject ENTYVIO.



What is ENTYVIO?

ENTYVIO is a prescription medicine used in adults for the treatment of:

- moderately to severely active ulcerative colitis (UC).
- moderately to severely active Crohn's disease (CD).

It is not known if ENTYVIO is safe and effective in children under 18 years of age.

SELECTED SAFETY INFORMATION

Do not receive ENTYVIO if you have had an allergic reaction to ENTYVIO or any of its ingredients. ENTYVIO may cause serious side effects including infusion-related and serious allergic reactions while receiving ENTYVIO or several hours after treatment. ENTYVIO may increase your risk of serious infections. Although unlikely, progressive multifocal leukoencephalopathy (PML), a rare, serious brain infection caused by a virus, cannot be ruled out. Liver problems can occur with ENTYVIO.

Please see Important Safety Information on [pages 22 and 23](#).

YOUR ENTYVIO SINGLE-DOSE PREFILLED PEN

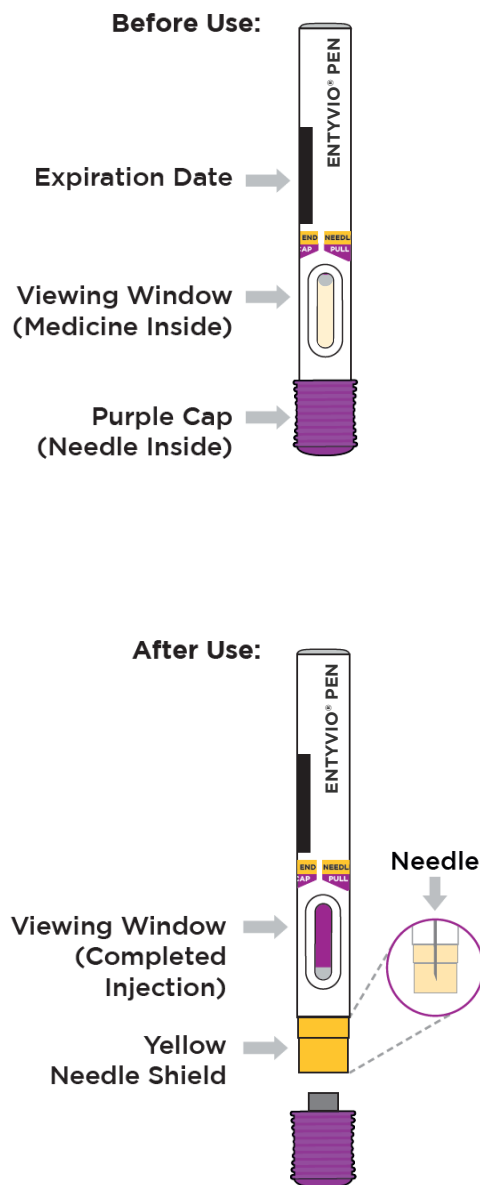

Please see Important Safety Information on [pages 22 and 23](#).

Important information you need to know before injecting ENTYVIO:

- Read and follow this Instructions for Use before you inject ENTYVIO.
- Your healthcare provider should show you how to use the ENTYVIO Pen before you use it for the first time.
- **ENTYVIO Pen is for subcutaneous injection only** (inject directly into fatty layer under the skin).
- **Do not** shake the prefilled pen.
- **Do not remove the purple cap from the prefilled pen until you are ready to inject.**
- **Do not** put or press your thumb, fingers, or hand over the yellow needle shield. The yellow needle shield is visible when the purple cap is removed.
- **Do not** use the prefilled pen if it is dropped or damaged.

Storing ENTYVIO

- Store your prefilled pen in the refrigerator between 36°F to 46°F (2°C to 8°C)
- Your prefilled pen can be left in its box at room temperature up to 77°F (25°C) for up to 7 days (for example, when traveling). **Do not** use the prefilled pen if it is left out of the refrigerator for more than 7 days.
- **Do not** freeze the prefilled pen.
- **Do not** leave the prefilled pen in direct sunlight.
- Throw away the prefilled pen in a FDA-cleared sharps disposal container if it has been left out of the refrigerator for more than 7 days, frozen, or left in direct sunlight. See [Step 14](#) for instructions on how to throw away (dispose of) the prefilled pen.
- **Always keep ENTYVIO Pens, the sharps disposal container, and all medicines out of the reach of children.**

STEP 1:
Remove the ENTYVIO PEN
box from the refrigerator

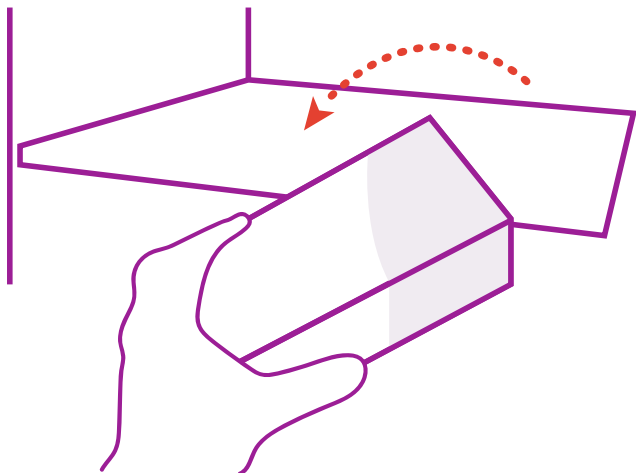

Figure A

Take 1 prefilled pen box from the refrigerator and check the expiration date on the box (see **Figure A**).

- **Do not** use the prefilled pen if any of the seals on the box are broken.
- **Do not** use the prefilled pen if the expiration date on the box has passed.

STEP 2:
Wait 30 minutes

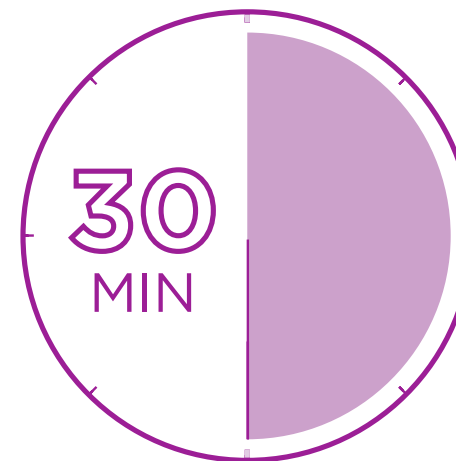

Figure B

Wait 30 minutes and let the prefilled pen come to room temperature (see **Figure B**).

- **Do not** warm the prefilled pen any other way.
- **Do not** let the prefilled pen sit in direct sunlight.
- **Do not** take the prefilled pen out of its tray until you are ready to inject.

Please see Important Safety Information on [pages 22 and 23](#).

STEP 3: Gather supplies

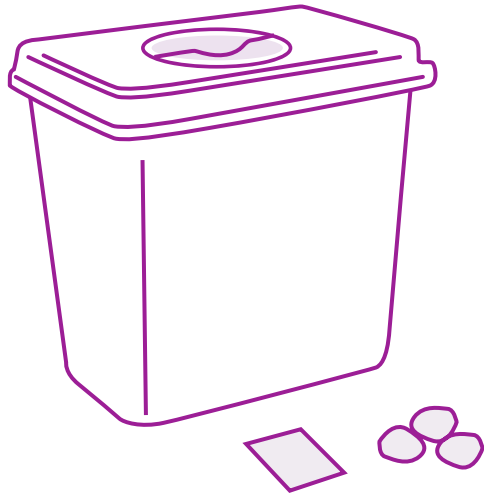

Figure C

Find a clean, flat surface like a table. Gather supplies that are not in the prefilled pen box (see **Figure C**).

- Alcohol pad
- Cotton ball or gauze
- Sharps disposal container (see **Step 14** “Throw away (dispose of) the prefilled pen” on page 17)

STEP 4: Wash hands

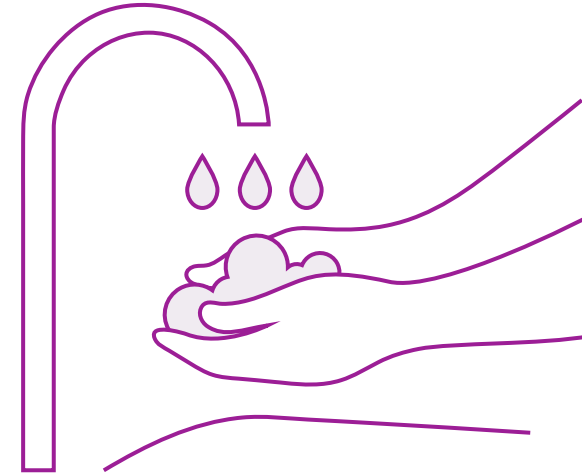

Figure D

Wash your hands with soap and clean water (see **Figure D**).

Please see Important Safety Information on **pages 22 and 23**.

STEP 5: Remove the prefilled pen from the tray

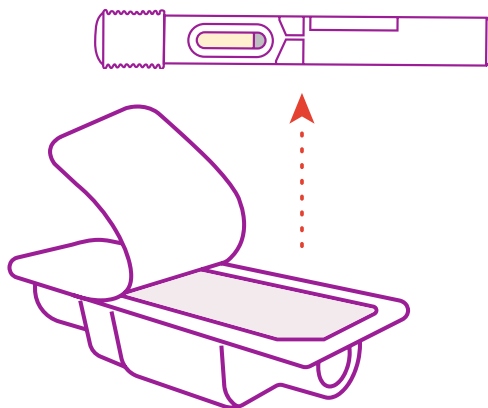

Figure E

Peel off the paper on the tray and lift the prefilled pen straight out (see **Figure E**).

- **Do not** shake the prefilled pen.
- **Do not** remove the purple cap from the prefilled pen until **Step 9**.

Please see Important Safety Information on **pages 22 and 23**.

STEP 6: Inspect the prefilled pen

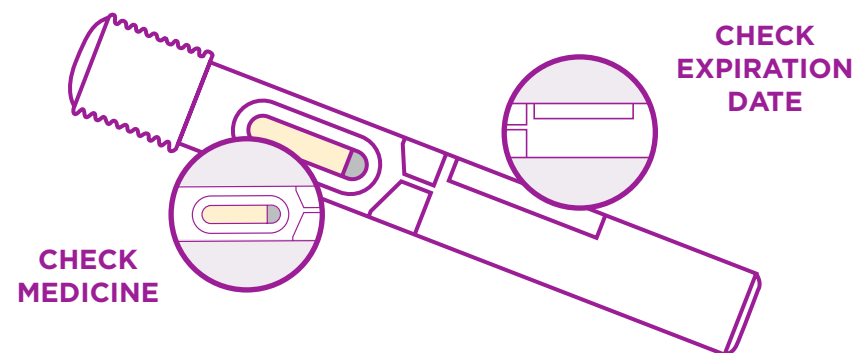

Figure F

Check the expiration date (EXP) printed on the prefilled pen and the medicine in the prefilled pen viewing window (see **Figure F**). The medicine should be colorless to pale yellow. It is normal to see air bubbles. Inspect the prefilled pen for any damage.

- **Do not** use the prefilled pen if the expiration date on the prefilled pen has passed.
- **Do not** use the prefilled pen if the medicine is cloudy or has particles floating in it.
- **Do not** use the prefilled pen if any part of it is damaged.

STEP 7: Choose injection site

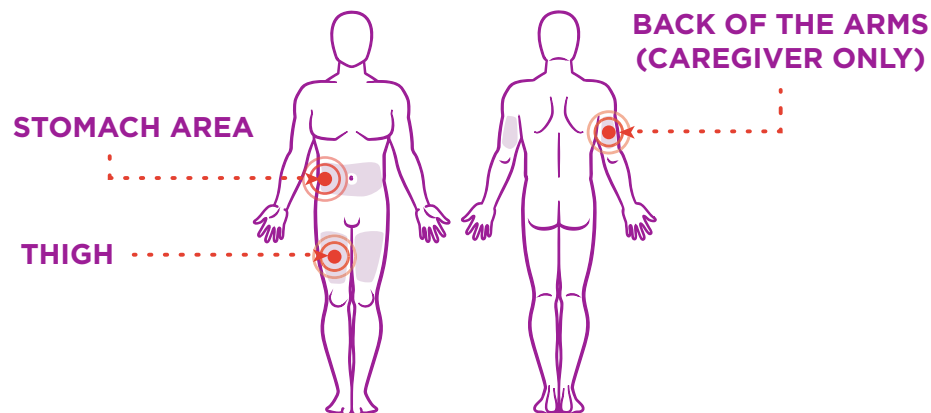

Figure G

Choose an injection site on your bare skin from one of the following (see **Figure G**):

- front of the thighs
- stomach area (avoid the area 2 inches around the belly button)

For caregivers only: back of the upper arms may also be used.

- **Do not** inject into the same spot you used for your last injection.
- **Do not** inject into moles, scars, bruises, or skin that is tender, hard, red, or damaged.

Please see Important Safety Information on **pages 22 and 23**.

STEP 8: Clean the injection site

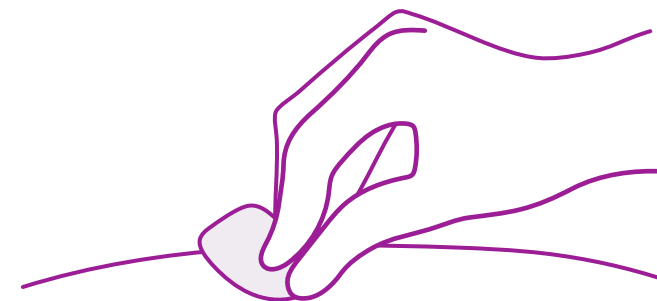

Figure H

Clean the injection site with an alcohol pad (see **Figure H**). Let your skin dry.

- **Do not** touch or blow on the cleaned injection site before you inject.

Continue to **Step 9**.

STEP 9: Remove the purple cap and throw it away

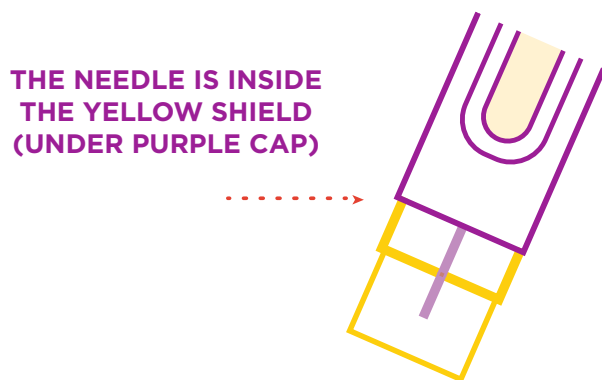

Figure I

When you are ready to inject, pull the purple cap straight off and throw it right away in the sharps disposal container (see **Figure I**).

- The needle is inside the yellow needle shield (under purple cap).
- **Do not** put or press your thumb, fingers, or hand over the yellow needle shield.
- **Do not** put the purple cap back on. This could accidentally start the injection.

Please see Important Safety Information on **pages 22 and 23**.

STEP 10: Place the prefilled pen on the injection site

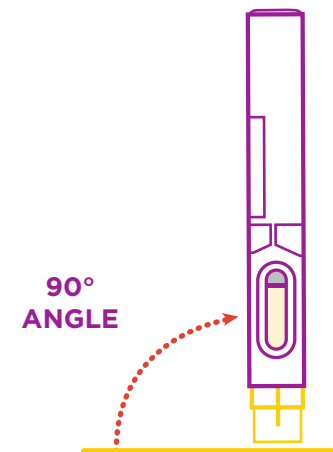

Figure J

- Hold the prefilled pen so you can see the viewing window.
- Place the yellow end of the prefilled pen flat on your skin at 90 degrees to the injection site (see **Figure J**).
- The needle is inside the yellow needle shield.
- **Do not** push down on the prefilled pen until you are ready to inject.

STEP 11: Start injecting ENTYVIO

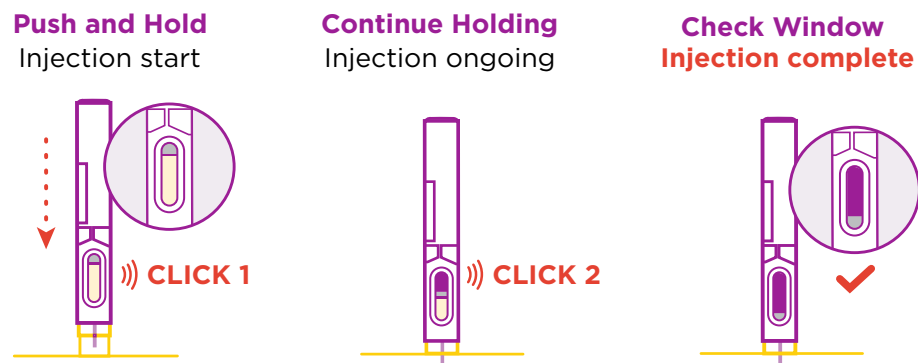

Figure K

Push the prefilled pen straight down and hold for at least 10 seconds (see **Figure K**).

- You may hear a first click when the injection starts.
- You may hear a second click. This is not the end of the injection.
- **Continue holding the prefilled pen** with constant pressure and watch the window turn purple.

Please see Important Safety Information on **pages 22 and 23**.

STEP 12: Complete injecting ENTYVIO

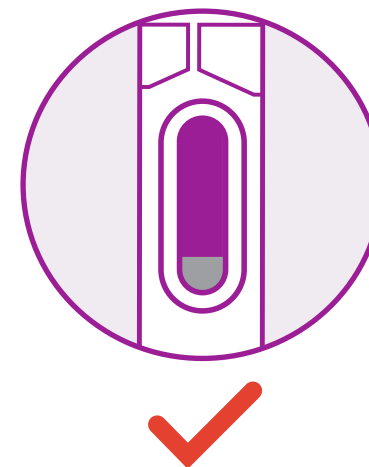

Figure L

Continue holding the prefilled pen with constant pressure until **the viewing window has filled with purple to make sure you have received your full dose** (see **Figure L**).

- You will see a small amount of gray in the viewing window. This is normal.
- If the viewing window did not fill with purple, you may not have received your full dose. Call your pharmacy or healthcare provider.

STEP 13:
Lift prefilled pen from skin

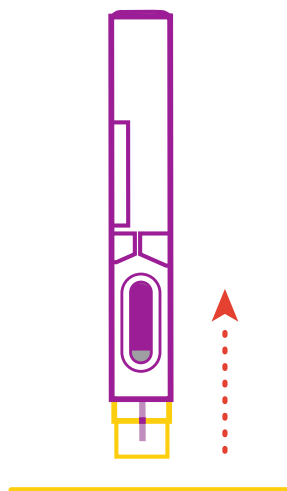

Figure M

Lift the prefilled pen from the injection site (see **Figure M). The yellow needle shield will drop down and lock over the needle.**

- When you remove the prefilled pen, if the window has not turned purple, or it looks like the medicine is still coming out of the prefilled pen, this means you have not received a full dose. Call your pharmacy or healthcare provider right away.
- You may see a small amount of blood at the injection site. If you do, press on your skin with a cotton ball or gauze.

Please see Important Safety Information on **pages 22 and 23**.

STEP 14:
Throw away (dispose of) the prefilled pen

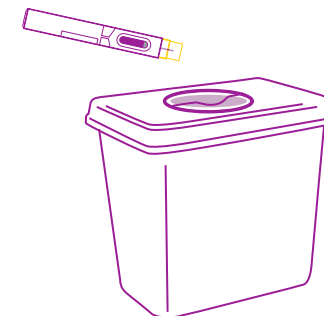

Figure N

Throw away (dispose of) the used prefilled pen in a FDA-cleared sharps disposal container right away after use (see **Figure N). **Do not** recycle or throw away the prefilled pen in your household trash.**

- Throw away the remaining supplies in your household trash or sharps disposal container.
- If you do not have a FDA-cleared sharps disposal container, you may use a household container that is:
 - made of heavy-duty plastic,
 - can be closed with a tight-fitting, puncture-resistant lid, without sharps being able to come out,
 - upright and stable during use,
 - leak-resistant, and
 - properly labeled to warn of hazardous waste inside the container.
- When your sharps disposal container is almost full, you will need to follow your community guidelines for the right way to dispose of your sharps disposal container. There may be local or state laws about how you should throw away needles and syringes.
- For more information about safe sharps disposal, and for specific information about sharps disposal in the state you live in, go to the FDA's website at: <http://www.fda.gov/safesharpsdisposal>.

NOTES

Important Safety Information

- **Do not receive ENTYVIO® if you** have had an allergic reaction to ENTYVIO or any of its ingredients.
- **ENTYVIO may cause serious side effects, including:**
 - **Infusion-related and serious allergic reactions** can happen while you are receiving ENTYVIO or several hours after treatment. You may need treatment if you have an allergic reaction. Tell your healthcare provider or get immediate medical help if you get any of these symptoms during or after an infusion of ENTYVIO: rash, itching, swelling of your lips, tongue, throat or face, shortness of breath or trouble breathing, wheezing, dizziness, feeling hot, or palpitations (feel like your heart is racing).
 - **Infections.** ENTYVIO may increase your risk of getting a serious infection. Before receiving and during treatment with ENTYVIO, tell your healthcare provider if you think you have an infection or symptoms of an infection, such as fever, chills, muscle aches, cough, shortness of breath, runny nose, sore throat, red or painful skin or sores on your body, tiredness, or pain during urination.
 - **Progressive Multifocal Leukoencephalopathy (PML).** People with weakened immune systems can get progressive multifocal leukoencephalopathy (PML) (a rare, serious brain infection caused by a virus). Although unlikely while receiving ENTYVIO, a risk of PML cannot be ruled out. PML can result in death or severe disability. There is no known treatment, prevention, or cure for PML. Tell your healthcare provider right away if you have any of the following symptoms: confusion or problems thinking, loss of balance, change in the way you walk or talk, decreased strength or weakness on one side of the body, blurred vision, or loss of vision.
 - **Liver problems** can happen in people who receive ENTYVIO. Tell your healthcare provider right away if you have any of the following symptoms: tiredness, loss of appetite, pain on the right side of your abdomen, dark urine, or yellowing of the skin and eyes (jaundice).

- **The most common side effects of ENTYVIO include:** common cold, headache, joint pain, nausea, fever, infections of the nose and throat, tiredness, cough, bronchitis, flu, back pain, rash, itching, sinus infection, throat pain, pain in extremities, and with injections under the skin: pain, swelling, itching, hives, bruising, rash, or redness at the injection site. These are not all the possible side effects of ENTYVIO. Call your healthcare provider for medical advice about side effects.
- **Before receiving ENTYVIO, tell your healthcare provider about all of your medical conditions, including if you:** have or think you may have an infection or have infections that keep coming back; have liver problems; have tuberculosis (TB) or have been in close contact with someone with TB; have recently received or are scheduled to receive a vaccine; or if you are pregnant, breastfeeding, plan to become pregnant, or plan to breastfeed.
- **Tell your healthcare provider about all the medicines you take, especially if you take or have recently taken** Tysabri (natalizumab), Tyruko (natalizumab-sztn), a Tumor Necrosis Factor (TNF) blocker medicine, a medicine that weakens your immune system (immunosuppressant), or corticosteroid medicine.

Please see the full **Prescribing Information, including the Medication Guide, for ENTYVIO and talk with your healthcare provider.**

ENTYVIO is available for:

- **intravenous (IV) infusion: 300 mg vedolizumab.**
- **subcutaneous (SC) injection: 108 mg vedolizumab.**

You are encouraged to report negative side effects of prescription drugs to the FDA.

Visit www.fda.gov/medwatch or call 1-800-FDA-1088.

What is ENTYVIO?

ENTYVIO is a prescription medicine used in adults for the treatment of:

- moderately to severely active ulcerative colitis (UC).
- moderately to severely active Crohn's disease (CD).

It is not known if ENTYVIO is safe and effective in children under 18 years of age.



**IF YOU HAVE QUESTIONS OR CONCERNS
ABOUT YOUR ENTYVIO PEN, PLEASE
CALL YOUR HEALTHCARE PROVIDER.**

**You can also call 1-877-825-3327
or visit www.ENTYVIO.com for
more information.**

**Visit [ENTYVIO.com/HowToSelfInject](http://www.ENTYVIO.com/HowToSelfInject) to watch a video with
step-by-step instructions for injecting ENTYVIO.**

©2024 Takeda Pharmaceuticals U.S.A., Inc. 500 Kendall Street, Cambridge, MA 02142.
1-877-TAKEDA-7 (1-877-825-3327). All rights reserved. TAKEDA and the TAKEDA logo
are registered trademarks of Takeda Pharmaceutical Company Limited. ENTYVIO and
the ENTYVIO logo are registered trademarks of Millennium Pharmaceuticals, Inc.
US-VED-3023v1.0 04/24